

**A printed or saved copy is an UNCONTROLLED copy.  
Check that it is the latest available version before use.**

## APPLICABILITY TABLE

**X**

indicates the businesses, within the division, to which this document applies.

Australian Vinyls / ModWood	<input type="checkbox"/>	Kleenheat	<input checked="" type="checkbox"/>	WesCEF Shared Services	<input checked="" type="checkbox"/>
Ammonia / Ammonium Nitrate	<input checked="" type="checkbox"/>	Sodium Cyanide	<input checked="" type="checkbox"/>	CSBP Fertilisers	<input checked="" type="checkbox"/>
				Decipher	<input type="checkbox"/>

## TABLE OF CONTENTS

<b>1. INTRODUCTION</b> .....	<b>3</b>
<b>2. DEFINITIONS</b> .....	<b>4</b>
<b>3. RESPONSIBILITIES</b> .....	<b>8</b>
3.1 BUSINESS UNIT MANAGER .....	8
3.2 TEAM LEADER OR SUPERVISOR / RESPONSIBLE OFFICER OR ACCOUNTABLE PERSON (FOR CONTRACTORS) .....	9
3.3 PLANNER SCHEDULER .....	9
3.4 EMERGENCY RESPONSE TEAM .....	9
3.5 EMPLOYEES.....	10
<b>4. TRAINING AND COMPETENCY</b> .....	<b>10</b>
4.1 AUTHORISING WORKING AT HEIGHT CERTIFICATES .....	11
4.2 REFRESHER TRAINING .....	11
4.3 OTHER RELATED TRAINING.....	11
<b>5. RISK ASSESSMENT</b> .....	<b>11</b>
5.1 HIERARCHY OF CONTROLS .....	11
<b>6. FALL INJURY PREVENTION SYSTEMS</b> .....	<b>12</b>
6.1 PERSONAL FALL ARREST EQUIPMENT.....	12
6.2 ANCHOR POINTS.....	13
6.3 STATIC LINES .....	14
6.4 LANYARDS.....	15
6.5 SAFETY CLIMBING SYSTEMS.....	17
6.6 RECORD KEEPING ON EQUIPMENT .....	17
<b>7. ROOFS / CEILING SPACES AND OPEN HOLES</b> .....	<b>17</b>
<b>8. OPEN HOLES OR EXCAVATIONS</b> .....	<b>18</b>
<b>9. REMOVAL OF FLOORING, HANDRAILS OR OTHER EDGE PROTECTION</b> .....	<b>18</b>
<b>10. DROPPED OBJECTS</b> .....	<b>18</b>
<b>11. WORK PLATFORMS, SCAFFOLD AND ACCESS EQUIPMENT</b> .....	<b>18</b>

<b>12. FIXED PLATFORMS &amp; WALKWAYS.....</b>	<b>18</b>
<b>13. LADDERS AND ACCESS EQUIPMENT .....</b>	<b>19</b>
13.1 FIXED LADDERS AND STAIRWAYS .....	19
13.2 TEMPORARY LADDERS TO SCAFFOLDING .....	19
13.3 PORTABLE LADDERS .....	20
13.4 PORTABLE STANDS .....	20
<b>14. MOVING EQUIPMENT BETWEEN LEVELS .....</b>	<b>20</b>
<b>15. SCAFFOLD .....</b>	<b>22</b>
15.1 SCAFFOLD CONSTRUCTION .....	22
15.2 SCAFFOLD WORKING PLATFORMS .....	23
15.3 SCAFFOLD GUARDRAILS .....	24
15.4 SCAFFOLD KICK / TOE BOARDS .....	24
15.5 MOBILE SCAFFOLD.....	24
15.6 FURTHER WESCEF SCAFFOLDING REQUIREMENTS .....	24
<b>APPENDIX 1 - ELEVATED WORK PLATFORMS.....</b>	<b>26</b>
<b>APPENDIX 2 - WORK ON ROOFS.....</b>	<b>26</b>
<b>APPENDIX 3 - CEILING SPACES.....</b>	<b>27</b>

## 1. INTRODUCTION

The purpose of this manual is to eliminate potential harm to all employees, contractors and visitors at Wesfarmers Chemical, Energy and Fertilisers (WesCEF) sites resulting from persons falling from one level to another or being affected by falling objects. It applies to:

- a. All WesCEF operating sites and offices.
- b. All employees, contractors and visitors.

The manual requires that a system of work for prevention of falls from height is established and maintained in all work situations. This can be achieved through:

- a. Where practicable, the elimination of the need to work where there is the risk of a fall.
- b. Conducting risk assessments before the commencement of work and at any time the scope of work changes or the risk of a fall increases.
- c. Selection of appropriate control measures using the hierarchy of controls, refer section 5.1
- d. Ensuring all equipment used is fit-for-purpose.
- e. Ensuring all persons responsible for, or performing work, where there is a risk of falling, are competent in the correct use of the site management systems for the prevention of falls, refer section 4.1
- f. Development of procedures for the use and disposal of all equipment that supports or lifts a person at height.
- g. The use of fall arrest equipment as the last option for a control measure (after all other control measures have been explored and deemed to be inappropriate), where it is not practicable to eliminate the risk of a fall.
- h. Due to the harsh environment and conditions experienced at CSBP sites, it has been deemed necessary to use only steel screw gate type Karabiners at CSBP sites.



**TRIPLE ACTION KARABINERS SHALL NOT BE USED  
AT CSBP WITHOUT APPROVAL FROM THE HEALTH AND SAFETY TEAM.**

- i. Scaff or Shark hooks are allowed to be used as a means of attachment by Scaffolders only. Where the use of Karabiners are an impost, approval maybe given to use Scaff / Shark hooks after consultation with the Emergency Services Team.
- j. Due to the possibility of ‘**Rollout**’ or ‘**Crush out**’ which is where the harness attachment point (dorsal D) becomes unattached from the lanyard point. The use of Double Acting Snap Lock hooks shall not be used on any WesCEF sites.

## 2. DEFINITIONS

### Work at Height

“Work at Height” is defined as whenever people are at risk of falling from, into or through one level to another.

A ‘Working at Height Certificate’ shall be issued for tasks that meet the following criteria:

- A person’s feet are greater than 1.8m above the ground and there are no fixed engineering controls in place (e.g. fixed handrails) which prevent the person falling, excluding fixed plant ladders,
- Using mechanical device to lift a person (e.g. elevated work platform, scissor lift, crane basket, forklift man-cage etc.),
- Removing flooring or handrails,
- Conducting work on or walking on roofs of any construction, or
- Where determined to be applicable by a risk assessment.

### Fall Injury Prevention Systems (FIPS)

Fall Injury Prevention Systems are systems designed to arrest or prevent a person falling from one level to another, whilst minimising the risk of injuries or harm during the fall. FIPS include fall restraint systems, fall arrest systems, catch platforms, scaffolding, safety nets and safety mesh.

### Restraint Technique

A combination of anchorage placement and lanyard length adjustment which will not physically permit the operator to reach a fall-risk position unless the lanyard is incorrectly adjusted.

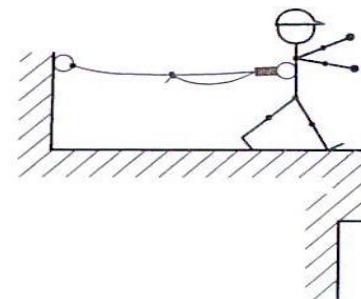

(a) Restraint technique  
- adjustable lanyard

### Restrained Fall

A pole-strap of length which will permit only a restrained fall when working on a pole

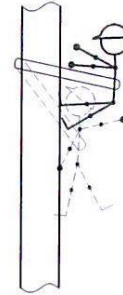

(b) Restrained fall - pole strap

### Limited Free Fall

A combination of anchorage placement and lanyard length which will permit only a limited free fall (<600mm)

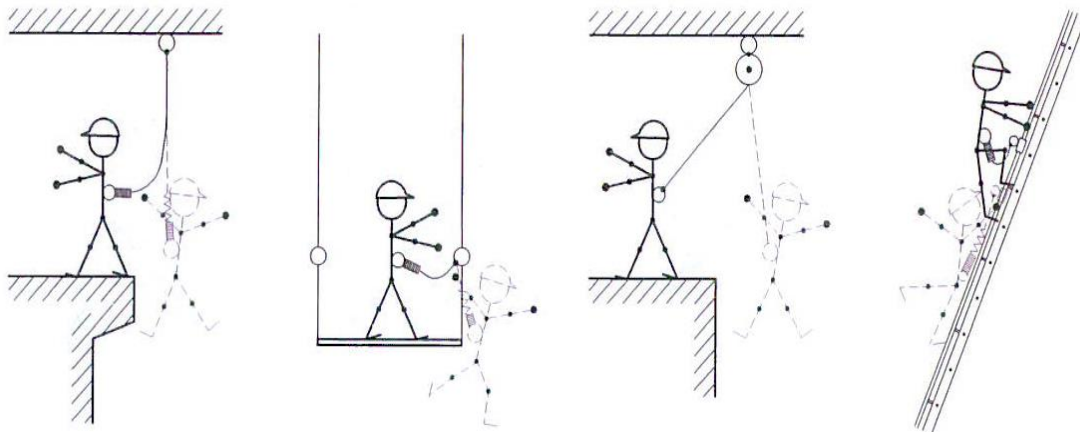

(c) Limited free fall – free-fall distance  $\leq 600$  mm

### Free Fall

Equip operators with personal fall-arrest equipment which will not prevent a fall but minimise the risk of injury in the event of a fall, maximum 2 metres free fall. This will likely involve static lines or lanyards with shock absorbing devices.

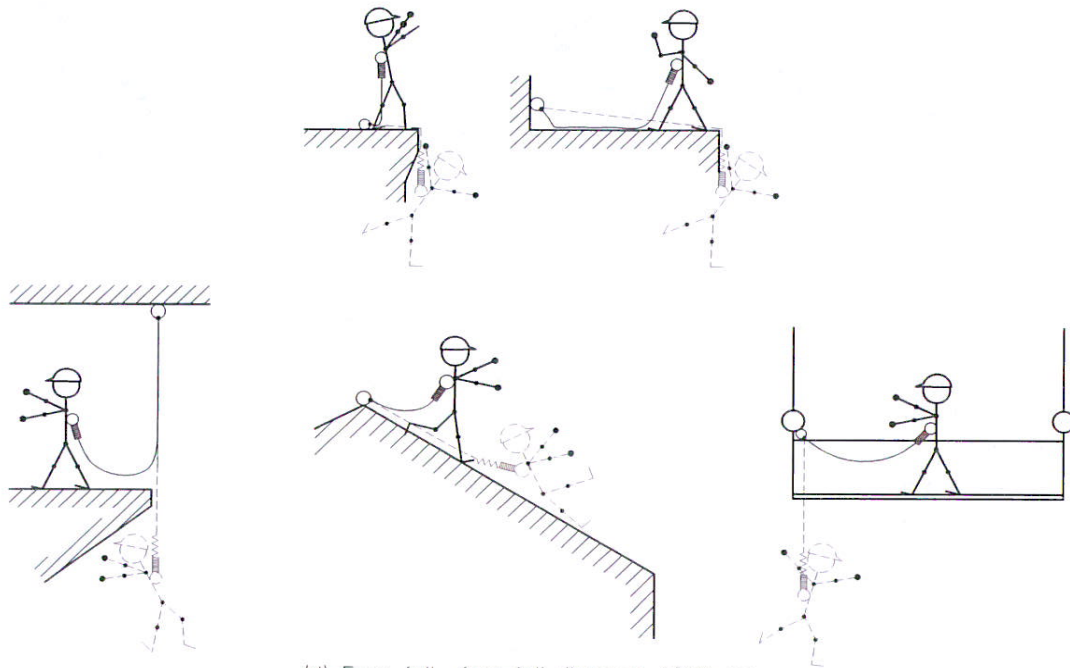

(d) Free fall – free-fall distance >600 mm

### Anchorage Point

A secure point of attachment on a structure to which a safety harness or fall restraint / fall arrest device, or lanyard, or lanyard assembly or static line may be secured.

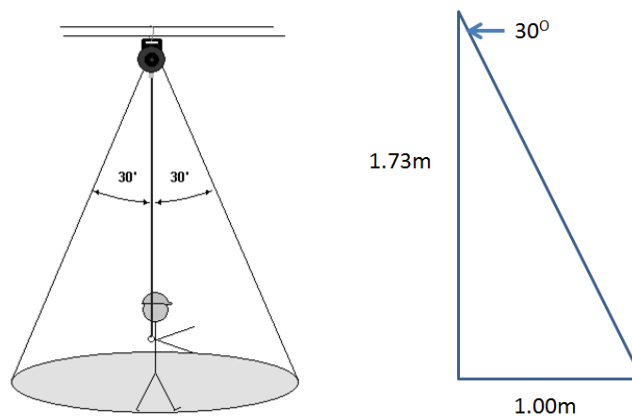

### Safety Harness

A full body harness with a fall arrest attachment point at the top dorsal position, i.e. between shoulder blades, which was manufactured and complies with AS1891.1 Industrial Fall Arrest Systems and Devices - Safety Belts and Harnesses.

## Lanyard

A lanyard is used to connect a safety harness to an anchorage point or static line in situations where there is a risk of a fall or when used in restraint mode to prevent a fall. Lanyards can be either adjustable or fixed length and incorporate the use of a shock absorber.

### Static Line (Permanent or Temporary)

A horizontal safety line or rail system to which a lanyard may be attached and which is designed to arrest a free fall, as per AS 1891.2 Industrial Fall Arrest Systems and Devices - Horizontal Lifeline and Rail Systems.

### Double Action Screw Gate Type Karabiners

Karabiners must be of steel construction and be of Double Action screw gate type design for CSBP sites.



### Scaff or Shark Hooks

Apparatus used to attach / anchorage to anchor point usually used by Scaffolders.



### Double Action Snap Hooks

This apparatus is not to be used on any WesCEF site



### Triple Action Alloy Karabiner

This apparatus is not to be used on CSBP Sites without approval from the Health and Safety team.



### Helmet Chin Straps

The use of Chin Straps shall be considered during the Risk Assessment process for all working at heights and accessing of roofs or tanks as to eliminate the potential of the helmet falling.

## 3. RESPONSIBILITIES

### 3.1 BUSINESS UNIT MANAGER

Business Unit Managers are responsible for:

1. Providing a safe system of work where persons are not exposed to the hazards of falling from any height or from being affected by falling objects.
2. Ensuring emergency response persons are trained and competent to perform emergency rescue from height.
3. Ensuring that work at heights shall not be undertaken without there being adequate fall prevention or fall protection measures in place.
4. Ensuring plant, equipment and PPE used for fall prevention or fall protection is compliant to this procedure.



5. Ensuring that information, instruction, training and supervision of all personnel is provided to enable them to safely perform their work at heights or safe from falling objects.
6. Ensuring risk assessments are conducted by competent personnel before the commencement of work and appropriate control measures are selected.
7. Ensuring that there is a system to regularly inspect and maintain in proper working condition all plant, equipment & PPE used for fall prevention or fall protection (as per AS1891).

### **3.2 TEAM LEADER OR SUPERVISOR / RESPONSIBLE OFFICER OR ACCOUNTABLE PERSON (FOR CONTRACTORS)**

Team Leader / Responsible Officer are responsible for:

1. Establishing where practicable, systems of work which eliminate the requirement to work at height.
2. Ensuring all personnel know and follow established procedures for work at height
3. Ensuring JSA's are developed and approved prior to the commencement of work and checking that required controls are in place when work is being undertaken.
4. Reviewing and signing completed JSA's.
5. Ensuring risk assessments are re-validated at any time the scope of work changes or the risk of a fall or falling object increases.
6. Ensuring only trained, competent personnel deploy fall restraint or fall protection controls where these are used.
7. Ensuring that fall protection equipment is:
  - (a) tested and certified for use,
  - (b) inspected by the user before use,
  - (c) re-tested & certified for use following a fall or where inspection has shown evidence of excessive wear or mechanical malfunction, and
  - (d) testing and inspection are only carried out by competent persons.

### **3.3 PLANNER SCHEDULER**

Planner / Scheduler are responsible for:

1. Ensuring that the requirements of this standard are included during the planning of the task (including maintenance shutdown's) by considering the hierarchy of control for the work being planned and making provision for appropriate controls to be available (eg. Elevated Work Platform, Scaffolding).

### **3.4 EMERGENCY RESPONSE TEAM**

The Emergency Response Team are responsible for:

1. Ensuring emergency services personnel are trained in rescue from height techniques.
2. Ensuring appropriate rescue equipment is available for performing a rescue at height.
3. Advising of WesCEF requirements for working at heights and equipment.

### **3.5 EMPLOYEES**

All employees, are responsible for ensuring they:

1. Participate in the development of the Job Safety Analysis (JSA) and comply fully with its requirements.
2. JSA to include a Rescue Plan.
3. Inspect all equipment intended to be used.
4. Do not commence work unless all control measures identified on the JSA are in place.
5. Review and re-sign the JSA if the scope of work or conditions change or the task ceases for any reason for an extended period of time and recommences.
6. Trained rescue staff to be available during working at height tasks. Prior notification of working at heights task to trained rescue staff.
7. Fire brigade 000 can always be called upon but have a delayed response.

### **4. TRAINING AND COMPETENCY**

All employees and contractors working at heights; or responsible for authorising work where there is a risk of falling shall be competent to the National Unit of Competency, RIIWH204D, 'Work Safely at Heights'.

Persons who are exposed to the risk of falling shall:

- a. Be able to participate in the risk assessment of the work.
- b. Know and understand the control measures for fall prevention.
- c. Be competent in the correct use of those control measures e.g. All PPE and equipment.
- d. Have a current license, ticket or certificate of competency for any plant being used as a control measure e.g. EWP, scaffold etc.

### 4.1 AUTHORISING WORKING AT HEIGHT CERTIFICATES

A person who authorises a Working at Height certificate shall be trained and competent in Working at Heights.

### 4.2 REFRESHER TRAINING

To maintain ongoing competency, authorisation and appointment, there is an expectation that people will meet the required critical safety refresher training. This should be conducted prior to or as soon as practical after the refresher period of three years or at any lesser interval if determined necessary.

### 4.3 OTHER RELATED TRAINING

Equipment training linked to working safely at heights can include:

- Mobile Work Platforms (W.P.)
- Scaffoldings (SB, SI, SA)
- Rigging & Dogging (DG, RB, RI, RA)
- Forklift (LF)
- Confined Space Entry

## 5. RISK ASSESSMENT

All persons required to perform work at height must understand and actively participate in WesCEF risk management processes.

### 5.1 HIERARCHY OF CONTROLS

Users of fall prevention equipment need to be aware how these systems are placed within the hierarchy of control for fall prevention, so that an assessment can be made as to whether the highest level of practical protection is being applied in case. The hierarchy of controls are:

1. **Elimination** - Eliminate the need to access the fall-risk area, e.g. by locating or relocating items requiring inspection, maintenance or other attention, elsewhere.
2. **Substitution** - Provide alternative means of access to the point or item to which access must be made which avoids the risk of a fall e.g. walkways or scaffolding.
3. **Engineering / Isolation** - Barricade or enclose the fall-risk so that it cannot be reached by, hard bunting, handrail scaffolding.
4. **Administrative** controls are required for all steps; JSA's or SOP, SWP for common tasks, training, signs etc.
5. **Fall Prevention PPE** - Must only be considered as a last resort and only if all other control measures are impracticable, unavailable or will introduce further hazards to the work. Provide PPE which either prevents a fall or reduces risk or severity of a fall.

---

**Note:** **Fall Prevention is preferable to Fall Protection.**

---

## 6. FALL INJURY PREVENTION SYSTEMS

WesCEF Fall Injury Prevention Systems arrest a person's fall from one level to another whilst minimising the risk of injuries or harm during the fall. Fall Injury Prevention Systems including the following:

### 6.1 PERSONAL FALL ARREST EQUIPMENT

Personal **fall restraint** and **free fall** (total restraint / restraint technique / restrained fall / limited free fall / free-fall) equipment harness shall:

- a. Comply with AS1891.1 and shall not be greater than ten years old.
- b. Be inspected prior to each and every use for wear and correct tagging.
- c. Have a formal documented inspection performed by an authorised, competent person at intervals not exceeding six months and be tagged to show inspection date.
- d. Only be attached to an anchor point meeting the requirements of section 6.2 Anchor Points.
- e. Be stored in a suitable location to prevent damage.

Personal **FALL ARREST** Equipment (limited free fall / free fall) shall additionally:

- a. Only be used when all other control measures have been explored and deemed to be inappropriate.
- b. Consist of a full body harness connected to an anchor point via either a retractable, adjustable or fixed length lanyard fitted with a shock absorber.



**Fall arrest equipment can only be effective if the free space below the level which the person is working is greater than the total length of the person plus the lanyard, plus the expanded length of the shock absorber plus a safety margin of 1 metre. The minimum distance is six (6) metres (7 metres if the anchor point is a static line).**

**Persons shall calculate the actual distance based on the equipment they will use prior to its use. Refer to Figure 1 for example.**

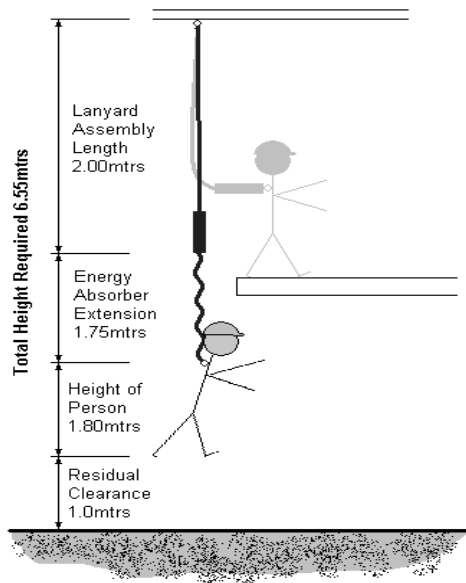
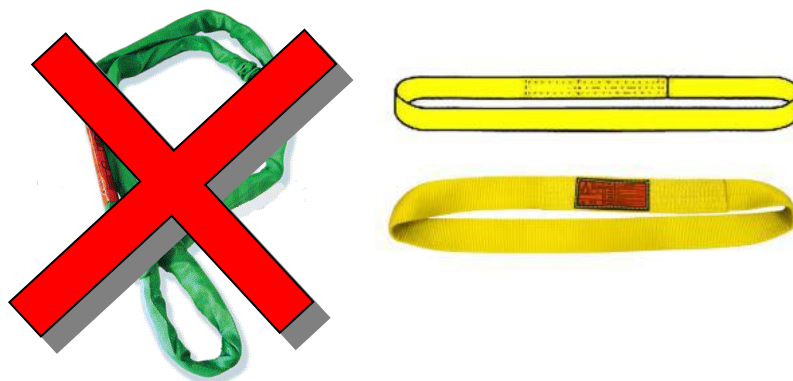

**Figure 1 - Clearance Distance – Using a Two (2) Metre Energy Absorbing Lanyard**

## 6.2 ANCHOR POINTS

Anchor points are used to attach Fall Arrest harness worn by a person via a connecting lanyard. Anchor points used in Fall Injury Prevention Systems (FIPS) shall be assumed to withstand the force of the load if a person was to fall. Anchor points for limited or free fall:

- Shall be located above head height of the person and located in a central location (within 30 degrees from vertical – Refer Section 2) that prevents a pendulum swing.
- Shall have the required clearance below the worker for the type of system being employed (e.g. length of lanyard, plus tear out distance, height of user plus safety margin.).
- Shall consist of a closed loop hook eye and must allow for the direct attachment of the safety device. Alternately, an endless loop lanyard can be wrapped around a suitable size steel structure (capable of holding 1500Kg) and the lanyard directly connected to both ends of the endless loop lanyard. Do not choke the endless loop lanyard as this reduces its rated capacity.



- d. Can be a “Static Line” as long as it has been correctly designed and installed (refer 6.3).
- e. NOT be ladder rungs, handrails, cable tray support etc.
- f. Can be scaffold if correctly designed to be on anchor point.
- g. Pipework is not to be used as an anchor point unless approved by a competent Mechanical Engineer.
- h. Shall be designed and installed in accordance with Attachments for Fall Arresting Systems (CSBP-ES-14-302-10).
- i. May be selected or constructed and each anchorage point of the system, other than an anchorage point supporting a static line, must have a capacity of at least:
  - Fall Restraint 6 kN (one person)
  - Limited Free Fall 12 kN (one person)
  - Fall Arrest 15 kN (one person)
  - Fall Arrest 21 kN (two people)

---

**Note:** Fall arrest anchor points that will be in place for a period of longer than one month shall be sign posted in accordance with the requirements of AS 1891.4.2000 Section 3.2.5 Anchorages. Ladder rungs shall not be used as anchor points. Handrail components shall not be used as anchor points.

---



**When considering the strength requirements for static lines, the anchor attachments to the structure shall also be considered (i.e.: can the structure support the intended static line loads?)**

The maintenance of anchor points shall be:

- a. Pre-use inspection by the user
- b. For permanent anchors in general areas a six (6) monthly formal, certified integrity check that is recorded.

### 6.3 STATIC LINES

Static lines are used where a range of movement is required in one direction. A typical example being when repairing or painting a roof where free movement along the roof is required but persons need to be prevented from falling off the edge of the roof. Static lines can be used as anchor points for either fall restraint or fall arrest equipment.

They shall be either:

- a. Permanent 12mm diameter steel (generally stainless steel) cable attached to permanent anchors or;
- b. They shall be temporary systems that use 20mm diameter flexible rope that is suitable for such use. Natural fibre rope shall not be used.

Anchor points for static lines shall be designed, approved and checked after installation by a structural engineer.

A number of commercial temporary static line systems are available which include attachment and tensioning devices. Only those systems that comply with AS1891 shall be used.

Maintenance of static lines will depend on its frequency of use and where it is used. However, the following is required:

- a. Pre-use inspection by the user.
- b. For permanent static lines a formal certified integrity check of the cable and anchors shall occur every six months and be recorded and the line tagged. Greater inspection frequency shall occur in aggressive environmental conditions.
- c. For temporary static lines, all components shall be checked prior to use, paying particular attention to any fraying, cracking or cuts in the rope be recorded and the line tagged.. The attachments shall be checked for distortion, cracks or sharp edges where the rope contact occurs.

#### 6.4 LANYARDS

Lanyards are used to connect persons who are wearing either fall restraint or arrest equipment to an anchor point. There are several types, being fixed length, shock absorbing and inertia reel retractable, which are detailed in the section below.

Those using a lanyard shall ensure that it is suitable for the proposed use and that it will provide the required fall restraint or arrest. All fall arrest situations shall require a shock absorber in the system.

Fixed length lanyards are used in either fall restraint or arrest situations. For fall restraint, the length needs to be such that, at maximum length, it prevents the person getting too close to any edge where the person could fall. For fall arrest, the summed length of the lanyard, the expanded shock absorber, the person and a one (1) metre safety margin, does not exceed the height that the person can fall.

Shock absorbing lanyards can be used in either total restraint or free fall arrest situations.

Endless loop lanyards (snake slings) are used to wrap around structural beams etc. in order to provide an anchor point for either fall restraint or arrest. An endless loop lanyard shall not be choked (one end threaded through the other) rather both ends shall be placed in the attachment device of the attaching lanyard.

Lanyards must be checked for compatibility of all components, including the harness attachment point and anchor attachment point which must meet the approved attachment hardware listed in section two (2).

All lanyards, with the exception of the endless loop, shall be fitted with approved attachment hardware listed in section two (2). It is important to inspect the work area where the lanyards will be used to ensure that they will not be damaged by sharp edges on beams or sheet steel, dangle in pools of water, oils or chemicals and the karabiners do not become jammed up with dust or crushed rock.

Any Karabiners that are unable to be fully screwed closed shall be replaced immediately.

Maintenance on lanyards shall be:

1. Pre-use visual inspection for cuts, abrasion, heat or oil or chemical damage and currency of operating life, which shall not exceed ten years from manufacture.
2. Pre-use check of the condition of karabiners to ensure that they operate freely, do not jam open and are not bent or damaged in any manner.
3. For shock absorbing lanyards, a pre-use check that the shock absorber has not opened in any manner indicating that it has arrested a fall.
4. A six monthly formal, certified integrity check by a registered organisation that shall be recorded and the lanyard tagged with date of inspection. This will be organised by the Emergency Services Team in conjunction with Area Planners.

#### 6.4.1 Inertia Reel Arrest Lanyards

Inertia reel arrest lanyards range in size and type from the short fibre to the longer retracting wire type.

They are particularly suitable where good flexibility in a working area is required. They are advantageous where persons climb up and down a structure as part of their work tasks. They are also useful for low height fall arrest situations where other types of shock absorbers cannot be used.



**It is not acceptable to rely on the auto-locking mechanism to restrict a person in a fall restraint mode (e.g. do not lock off and lean on the device).**

Persons using an inertia reel lanyard shall:

- a. Conduct a pre-use inspection of the whole length of the inertia reel, checking for cuts and tears on fibre type and damaged, “bird caged” or broken wires on wire type devices.
- b. Check the inspection tag to ensure that a formal inspection has occurred within the last six (6) months.
- c. Check for damage on the housing and cable or fibre entry point.
- d. Check for the correct and immediate operation of the locking device when a quick pull is applied to it.

Maintenance required on these items includes:

1. A formal and documented inspection every six (6) months conducted by a competent person.
2. Annually an internal inspection of the device by an authorised service agent (in the absence of recommendation specified by the manufacturer) shall occur.
3. Tagging and recording (log record) of the device to indicate that the inspection has occurred.



## 6.5 SAFETY CLIMBING SYSTEMS

Safety climbing systems are essentially a vertical static line or rail that runs up the middle of the ladder or tower.

They are generally used on long fixed ladders on items such as stacks, drill rigs, radio towers etc. A person wearing a suitable harness connects to the static line via a short lanyard and a running attachment device. In the event of the person losing their footing, the attachment device grabs the wire and stops the person falling.

Persons using such devices shall be:

- a. Trained and deemed competent in the use of them paying particular attention to installing the running attachment device correctly.
- b. Carry out a pre-use inspection of the running static line and continuous inspection as they climb.



---

**Note:** The required maintenance on the system is the same as for static lines.

---

## 6.6 RECORD KEEPING ON EQUIPMENT

There shall be a system to ensure that all equipment that lifts or supports a person working at height is recorded on a register that contains the following details:

- Identification Number.
- Maintenance History.
- Inspection Results.
- Modification made since purchase / commissioning.
- Purchase and disposal dates.
- Corrective actions or repairs made.

Register shall be kept by the Emergency Services Team.

## 7. ROOFS / CEILING SPACES AND OPEN HOLES

Working on roofs and in ceilings presents risk to the safety of persons working in those areas. Risk assessments (JSA) shall be performed to identify and control hazards from such work. The following Appendices provide guidance and detailed requirements on these activities respectively:

- Appendix 2 - Work on Roofs
- Appendix 3 - Ceiling Spaces

### 8. OPEN HOLES OR EXCAVATIONS

Open holes and excavations pose a fall and trip risk. For further details refer to WesCEF Excavation Procedure ([WCEF-PD-OHS-040-05](#)).

### 9. REMOVAL OF FLOORING, HANDRAILS OR OTHER EDGE PROTECTION

When flooring or handrails including (or any other form of edge protection) is removed and an opening created which exposes a person to a fall from height risk hard barricading shall be put in place that prevents access to the exposed opening. All personnel accessing the barricaded area must be protected by a fall injury prevention system. Exposed openings must never be left unattended, even for short periods without hard barricading in place.

Where practicable, hard barricading shall meet the edge protection requirements of AS1657-2013 and be installed a sufficient distance from the exposed edge to eliminate the potential for a person to fall. The barricading must be of sufficient strength and suitably fixed to sustain itself under the imposed actions of plant and people (i.e. it can withstand plant vibration, will stay in place if reasonable force applied to it by a person, at least 0.55kN).

Where a hard barricade not meeting AS1657-2013 (e.g. single scaffold tube) is used as protection for a fall risk greater than 1.8m, the barricading shall be erected at a distance greater than 2.0m from the exposed edge.

### 10. DROPPED OBJECTS

Refer to Dropped Object Prevention ([WCEF-GM-OHS-040-03](#)).

### 11. WORK PLATFORMS, SCAFFOLD AND ACCESS EQUIPMENT

Work platforms position personnel and equipment so that work can occur safely. Platforms may be either permanent or temporary. Specific requirements for work platforms are in Appendix 1. Specific requirements for scaffold are in Appendix 2.

Equipment used to access work platforms (ladders, portable stands etc) may be either temporary or permanent. Access equipment should not be used as a work platform.

Work Boxes are specifically designed to enable persons to be transported and perform work whilst suspended at height from a crane. Guidance in procedure and detailed requirements for work boxes are in procedure Mobile Crane Safety ([WCEF-PD-OHS-040-09](#)).

---

**Note:** Use of ladders form a significant proportion of the risk from working at heights at WesCEF. Items must not be carried by hand and three points of contact must be maintained at all times when ascending or descending ladders.

---

### 12. FIXED PLATFORMS & WALKWAYS

There are fixed platforms and walkways throughout WesCEF work sites. For detailed requirements refer to engineering standard Fixed Platforms, Walkways, Stairways and Ladders ([CSBP-ES-14-301-05](#)).

Persons working on or travelling across fixed platforms or walkways shall:

- a. Not stand on any of the handrail structure.
- b. Not overstretch over the handrails, thus compromising their safe work position.
- c. Ensure that the self-closing bar or gate is closed after entering the platform area.
- d. Not erect ladders close to the edge of platforms such that they are then higher than the height of the handrail. If maintenance is required on items such as light poles then alternate methods such as scaffolding or EWP shall be employed.
- e. Not at any time rely on handrail components as an anchoring point for fall arrest equipment.

### **13. LADDERS AND ACCESS EQUIPMENT**

Ladders and access equipment include fixed ladders and stairways, temporary ladders to scaffolding, portable stands and portable ladders in general.

Ladders are not commonly used as work platforms and then only for very light duty work such as changing a light globe or when special equipment and control measures are put in place. Typical examples include electrical pole work using a ladder, pole strap and work positioning harness.

Ladders shall have maintenance schedules in the relevant system for periodic inspections to ensure that they remain in adequate condition to perform their intended task. The frequency of the inspections shall be determined by:

- a. The work environment that they are exposed to.
- b. The frequency of their use.
- c. The work load that they are exposed to.

In addition to the above all ladders shall be checked regularly for adequacy.

#### **13.1 FIXED LADDERS AND STAIRWAYS**

It is WesCEF policy to use stairs for fixed access to an area. Where this is not possible, sloped ladders are used. Where this is not possible, vertical ladders are used.

All fixed ladders and stairways shall be designed and constructed in accordance with engineering standard Fixed Platforms, Walkways, Stairways and Ladders ([CSBP-ES-14-301-05](#)).

Fixed ladders shall be regularly inspected in accordance with the local audit schedule.

Persons using fixed ladders shall:

- a. Visually check the condition of the ladder prior to climbing and continuously check its condition whilst climbing it.
- b. Maintain three points of contact whilst climbing.
- c. Ensure that materials are lifted and lowered in an approved manner.

#### **13.2 TEMPORARY LADDERS TO SCAFFOLDING**

Temporary ladders used to access scaffolding shall be securely attached to the scaffolding in order to prevent persons using the ladder in any other location.

Persons shall only access scaffolding using such a ladder and shall not either climb up the side of the scaffolding or lean a portable ladder against the scaffolding to gain access.

### 13.3 PORTABLE LADDERS

Any ladder that is capable of being transferred from one location to another shall be considered a portable ladder. All portable ladders shall be designed and constructed to meet AS/NZS 1892.

Any ladder that is found to be faulty and cannot be effectively repaired shall be disposed of in a manner that prevents its re-use. To avoid concealment of defects in wooden ladders, clear varnish or oil must be used as a protective coating instead of paint. Domestic standard ladders shall not be used at WesCEF.

Persons using a portable ladder shall:

- a. Inspect the ladder prior to use. Pay special attention to the condition of the ladders rubber feet. Any faulty ladders shall be tagged “Out of Service”.
- b. Ensure that the ladder will be positioned on a level and firm ground that is capable of holding the weight of the ladder and the person climbing on it.
- c. When either a single or extension ladder is used, on first climbing the ladder it shall be footed by another person and the ladder shall be tied off at the top prior to any other task being performed.
- d. Maintain three (3) points of contact.
- e. Not stand on the top two rungs of the ladder.
- f. Remain within the vertical supports of the ladder.
- g. Items shall not be carried up or down a ladder unless carried in an approved hands free carry bag. Items of excessive weight shall not be carried up or down a ladder. Any item carried up or down the ladder must not affect the balance of the person using the ladder. Consideration should be given to the use of a rope or other suitable means to haul up tools and equipment. Maximum loading in such bags or backpacks is 20 kilograms. Refer to Section 14 of this procedure.
- h. Ensure that the metal spreader bar is locked into position on a step ladder prior to using it.
- i. Ensure that the correct lean angle is achieved for single and extension ladders by ensuring that the height of the ladder is not more than 4 times the distance from the foot of the ladder to the edge it is leaning on. (4:1 Ratio).

### 13.4 PORTABLE STANDS

Portable stands shall be designed and purpose built to an appropriate engineering standard. Prior to using a portable stand a risk assessment shall be conducted and consider factors such as the height and size of the stand as well as the ground and access to the stand.

Where a portable stand is fitted with wheels, the wheels shall be locked whenever the stand is being used. The stand shall only be used on a suitable surface capable of supporting the wheel loadings. Portable Stands shall be inspected to confirm as adequate before each use and as required after that.

## 14. MOVING EQUIPMENT BETWEEN LEVELS

Where loads are too heavy or awkward to utilise hands free bags or backpacks to carry between levels, a safe lifting system must be established and used. The size and mass of equipment must be assessed and the most appropriate lifting device selected for use. For small tools and equipment a rated rope and pulley system with

load rated lifting bag (or other device) conforming to AS4991 shall be used. E.g. SpanSet® Safe Lifting Kit 50kg – Figure 2.

The use of gin wheels at WesCEF is not allowed. Items must not be carried by hand on ladders and when using stairs items can only be carried in one hand to allow for use of the hand rail.



**Figure 2 - SpanSet® Safe Lifting Kit 50kg**

## 15. SCAFFOLD

### 15.1 SCAFFOLD CONSTRUCTION

All scaffolds must comply with the requirements detailed in AS4576: *Guidelines for scaffolding* and the AS1576 Series: *Scaffolding*. Additionally:

1. Scaffolds must be constructed, modified and maintained by a licensed scaffolder who has completed a Job Safety Analysis before commencing erection or dismantling
2. Scaffolds must be constructed and dismantled in such a manner that ensures, as far as is practicable, personnel erecting or dismantling are protected from falling from height. Preferentially:
  - (a) An overhead anchor point, independent of the scaffold, should be established which personnel constructing the scaffold can attach a fall arrest harness to and remain attached throughout the erection/dismantling of the scaffold or;
  - (b) Be constructed progressively in one metre vertical lifts so that personnel constructing/dismantling the scaffold are protected from falling by adequate edge protection
  - (c) Be constructed in such a manner that personnel can access rated anchor points as part of the scaffold (or adjacent structural steel) that will adequately arrest a fall prior to personnel impacting the ground or objects.
3. Scaffold boards used as temporary foot holds for scaffolders during construction must be secured against movement
4. Be fitted with a red Scafftag during construction and a signed and dated green Scafftag on completion that clearly marks its load capacity

Persons working on scaffold platforms shall:

1. Check the Scafftag for currency prior to checking the scaffold for general condition. If any faults are noted then turn the Scafftag to the red side and request a competent scaffolder to check the scaffolding
2. Only access the scaffolding via its fitted ladder or stairway
3. Only use the scaffold to its maximum load capacity
4. Ensure that their work activities do not allow tools or materials to fall onto persons below
5. Not use the scaffold as an attachment point for lifting equipment such as chain blocks etc, unless a competent scaffolder has installed it as a lifting device
6. Where scaffolds are fitted with wheels, the wheels shall be locked whenever the scaffold is being used
7. Not use a mobile scaffold where either it or persons on it will come in close proximity to live electrical equipment such as bus bars etc

### 15.2 SCAFFOLD WORKING PLATFORMS

Scaffold platforms at WesCEF must be constructed with steel or solid Karri timber hardwood boards.

Hardwood boards must be used in accordance with Ammonium Nitrate Safety ([CSBP-GM-11-037-01](#)) and must not be used in a manner that they can be ignited by hot surfaces. At all times, wooden boards are to be separated from hot surfaces by an air gap of at least 40mm.

Laminated veneer (LVL) timber boards are not to be used unless approved via risk assessment by the relevant Production Manager. Additionally, the boards must be:

- a. Proof tested for strength immediately prior to use at CSBP,
- b. Supplied with most recent certificate of proof testing,
- c. Supported by an intermediate transom at intervals not greater than one metre.
- d. Marked with:
  1. mill number,
  2. safe working load limit/working load limit,
  3. AS/NZS 1577:2013 compliance,
  4. maximum span distance,
  5. month and year of original proof testing
- e. Stored:
  1. Under cover and kept dry or,
  2. If allowed to become wet:
    - (a) Planks shall be stored well clear of the ground on level supporting bearers,
    - (b) Bearers shall be spaced such that the maximum design span and overhang are not exceeded,
    - (c) Spacers shall be placed between each layer of planks and shall be placed in near vertical alignment above the bearers,
    - (d) The spacers shall be of sufficient thickness to enable circulation of air between the layers of LVL planks,
    - (e) The stack shall be in a well-ventilated location

All working platforms shall be:

- a. Free from any tripping hazards and level, slip resistant and firm
- b. The planks shall have no gaps greater than that required for lashing
- c. Planks or working surfaces shall be secured
- d. Stairs shall be in straight flights and not less than 500 mm in width

- e. The minimum headroom for stairs and clearance above landings shall be 1850 mm
- f. Opening in hand railings for downward access from a platform shall be fitted with a self-closing gate
- g. Planks must be chosen for the correct application taking into account the plant they will be used in

### 15.3 SCAFFOLD GUARDRAILS

- a. Guardrails shall be securely fixed and parallel to the platform
- b. The top rail should be between 900 mm and 1100 mm from the platform with mid rail at 600 mm unless fitted with an infill panel
- c. When guardrails are omitted at the working face or adjacent to a structure/building, the gap between the structure / building and platform edge, shall be less than 100mm

### 15.4 SCAFFOLD KICK / TOE BOARDS

- a. Planks shall extend 150mm above the surface of the platform with no gaps to the platform > 10 mm
- b. The kick / toe board shall be secured and extend around the entire work platform, unless the kick / toe board can be omitted only due to access requirements. This gap between the working face, and structure, shall be less than 100 mm (to prevent object or person falling).









### 15.5 MOBILE SCAFFOLD

- a. Fixed scaffold should be used in preference over mobile scaffold where possible.
- b. The height of the mobile scaffold, from the bottom of the scaffold to the top handrail, should be no greater than double the minimum base dimension (e.g. if the minimum base dimension is 2m, the height of the scaffold must be less than or equal to 4m).
- c. Reduce the height to base ratio or provide extra support (i.e. outriggers) if the mobile scaffold will be:
  - 1. Sheeted or likely to be exposed to strong winds;
  - 2. Loaded with heavy equipment of materials;
  - 3. Used to hoist heavy materials; or
  - 4. Used for operations involving heavy or awkward equipment (i.e. blasting/water jetting).
- d. All wheel brakes on mobile scaffold are to be locked unless moving the scaffold.

### 15.6 FURTHER WESCEF SCAFFOLDING REQUIREMENTS

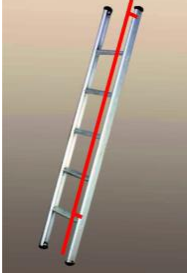
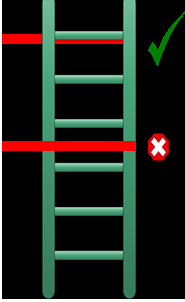
In addition to the requirements detailed in AS4576: *Guidelines for scaffolding* and the AS1576 Series: *Scaffolding* the requirements below shall be adhered to on WesCEF sites and form part of the risk control measures with respect to scaffolds.

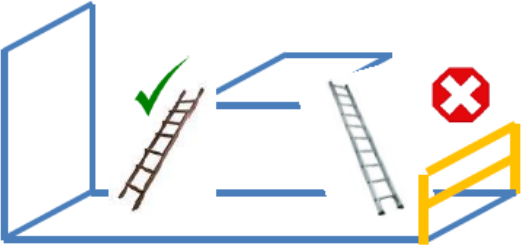

<p>The ends of scaffold tubes shall have end caps placed on them.</p>		<p>Any scaffold tube which presents a risk of head strike, shin strike or protrudes into a walkway will be fitted with 'scaffoam' to reduce the severity of injury.</p>	
<p>All tools used to construct scaffold more than 2.0m from the ground level shall be affixed to the scaffolder by a lanyard system.</p>		<p>Scaffold clips shall not be thrown through the air. Scaffold clips shall be hoisted to the appropriate level using a suitable lifting bag or similar apparatus. Refer to section 14.</p>	
<p>Scaffold ladders must have an additional handrail fitted to the outside length of the ladder.</p>		<p>Scaffolding tubes must not foul the rungs of the ladder or create a trip or catch point for those using the ladder.</p>	
<p>Where possible scaffold stairs should be used as a safer alternative to a ladder.</p>		<p>Scaffold platforms must be fitted with a swing type safety gate to prevent falls from height.</p>	
<p>Where a scaffold ladder is used in plant or buildings above the ground floor the positioning of the ladder must not create a fall from height hazard over the handrails unless protection is provided.</p>			

### APPENDIX 1 - ELEVATED WORK PLATFORMS

Refer to WesCEF Elevated Work Platforms ([WCEF-PD-OHS-040-08](#)).

### APPENDIX 2 - WORK ON ROOFS

Prior to commencing any work on a roof a JSA **shall** be completed and consideration shall be given to.

- a. The nature of the work to be conducted. Is it a roof replacement or just access to service equipment on the roof?
- b. The condition and material of the existing roof and support structure.
- c. Is there wire mesh installed under brittle roof material?
- d. The location of the roof relevant to other areas of the plant or electrical lines.
- e. The slope of the roof and how to access / egress area.
- f. How tools, materials and equipment will be raised and lowered and stored on the roof.
- g. How a person will be anchored to a suitable anchor point and how to install / test structure if used.

Persons who are going to work on a roof shall ensure that:

- a. The structural integrity of the roof has been determined prior to accessing it, storing material or rigging.
- b. If the roof material is brittle or its soundness cannot be determined then boarding over the brittle or unsound sections shall be installed by a competent person.
- c. Signage stating ‘DANGER FRAGILE ROOF – USE WORKING PLATFORM’ is installed.
- d. All workers on roofs (including those installing fall prevention/protection systems) are to be protected from falling to another level at all times. This includes falls off of or through brittle sections of the roof. Fall restraint (with “100% hook-up”) used with edge protection is an example of an acceptable control.
- e. If extensive roof repairs or replacement work is being conducted that requires open roof areas to be created, a static line shall be installed to provide the required fall restraint. This shall be continuously adjusted to provide correct fall restraint.
- f. The means of gaining access and egress to the roof is a safe practice (ladders, scaffold etc).
- g. The means of raising and lowering material, tools and equipment is performed in a safe manner.
- h. Consideration must be given to the rescue of a casualty injured on the roof.

## APPENDIX 3 - CEILING SPACES

Ceiling spaces are to be given the same consideration as Confined Spaces.

Prior to working in or accessing any ceiling space a JSA **shall** be conducted. Appropriate control measures determined by the JSA shall be implemented. Consideration shall be given to:

- a. Access to and egress from ceiling spaces.
- b. Atmospheric conditions within the ceiling space.
- c. Supporting surface strength and condition
- d. Communication process.
- e. Electrical hazards and fire risks
- f. Possible hazardous materials contamination.
- g. Physical effects of working in the ceiling space.
- h. Rescue procedures

---

**Note:** When moving around in the ceiling space, a temporary platform such as boarding can assist.

---

**A printed or saved copy is an UNCONTROLLED copy.  
Check that it is the latest available version before use.**

<b>Title:</b>	<b>WORKING AT HEIGHT</b>
<b>Number:</b>	<b>WCEF-PD-R&amp;S-0018</b>
<b>Version Number:</b>	<b>4.0.0</b>
<b>Date Revised:</b>	<b>03 November 2020</b>
<b>Owner:</b>	<b>Helen Hoang</b>
<b>Authoriser:</b>	<b>Simon Guy</b>
<b>Reasons for Creating or Amending Document:</b>	<b>New or Amended Process</b>
<b>Actual Change Details:</b>	<b>Section 15.5 added fo addition requirements around mobile scaffold.</b>